

ACROSS THE BATTLEFIELD



XB-06012 | 6+ 497
PCS/PZS



MILITARY
CAR





x5

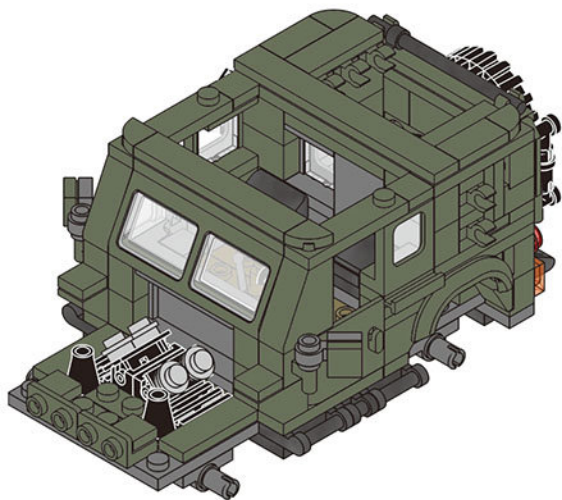

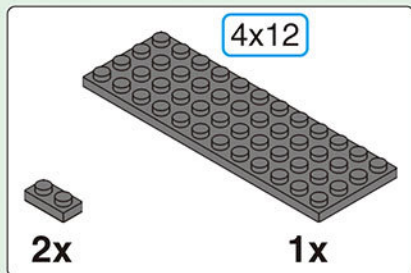

1-1

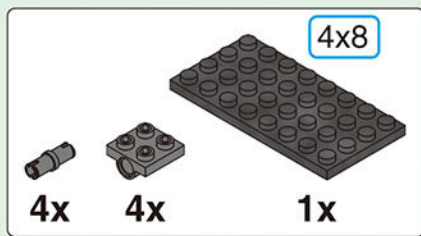
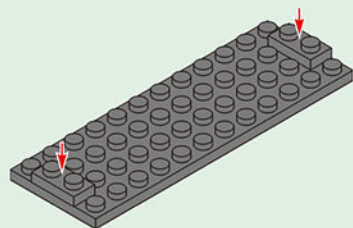

1-2

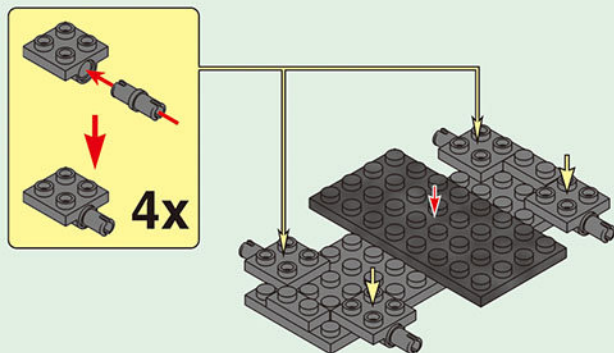

6x8

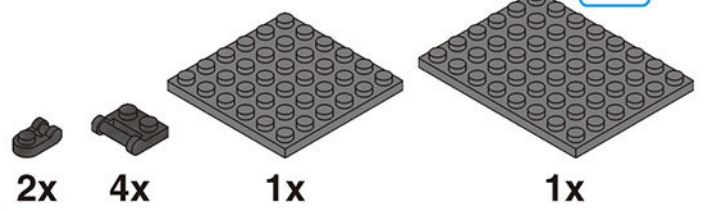

1-3

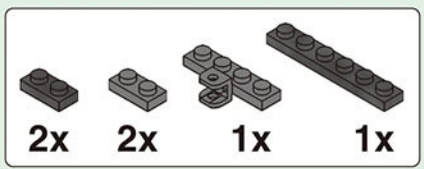
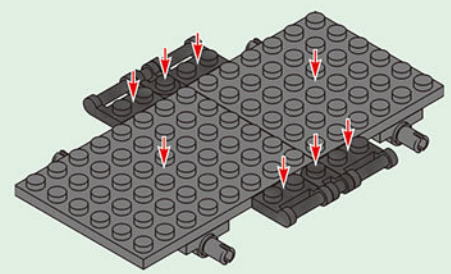

1-4

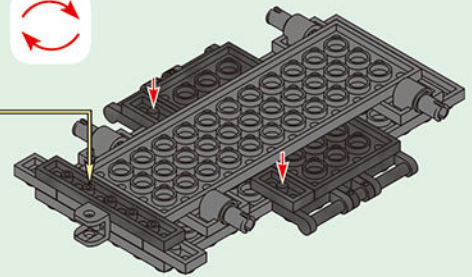
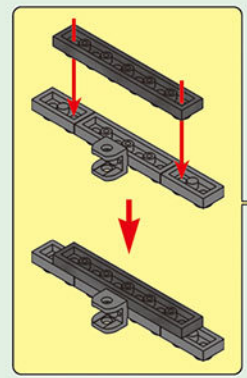

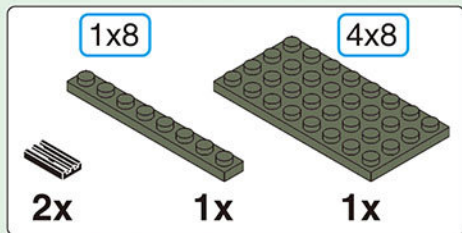

1-5

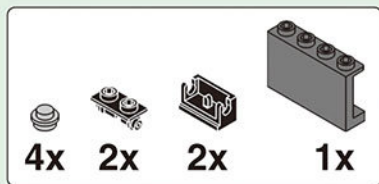
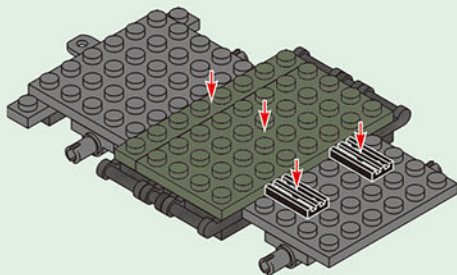

1-6

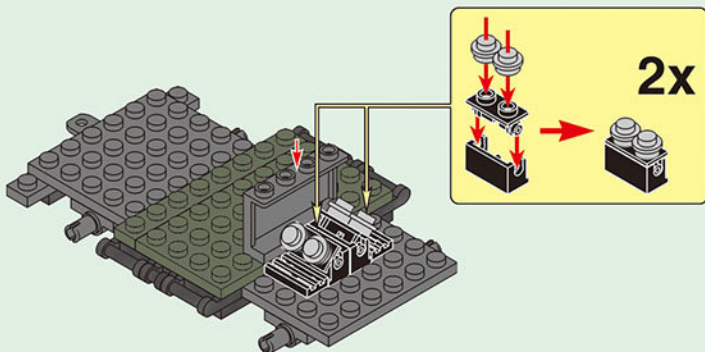

1x3



1x



2x



2x



2x



2x

1-7

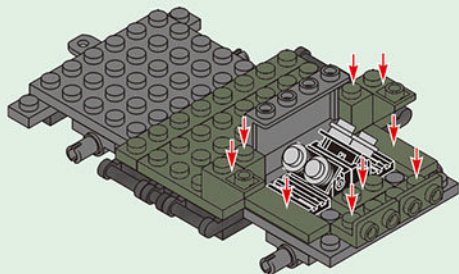

4x



2x



2x

1-8

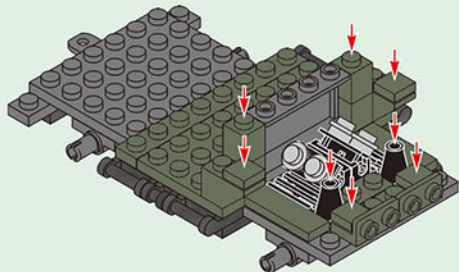

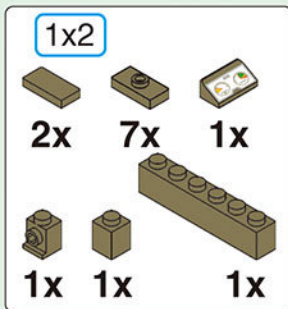

1-9

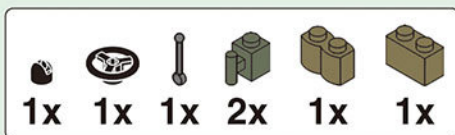
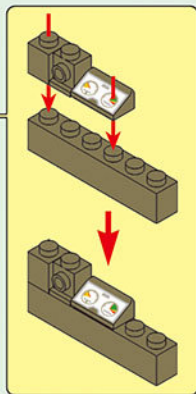
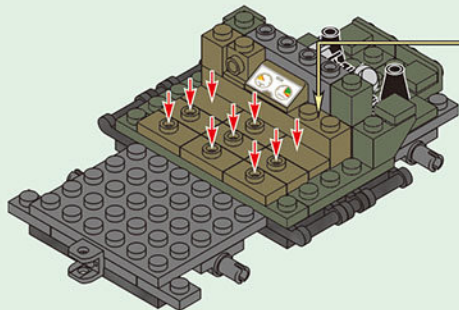

1-10

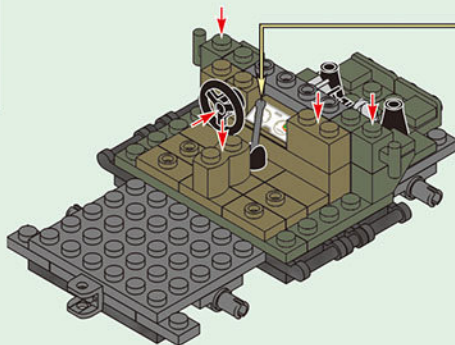

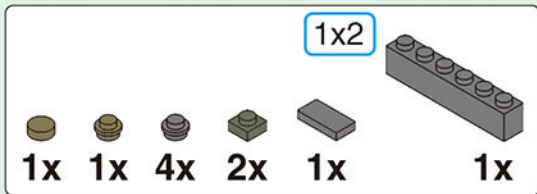

1-11

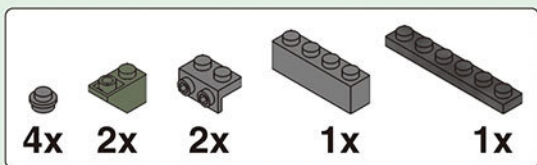
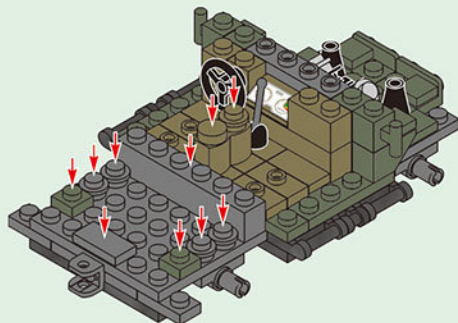

1-12

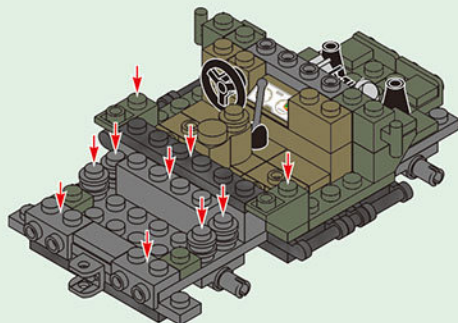

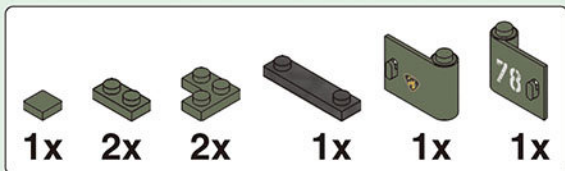

1-13

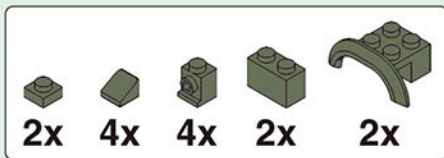
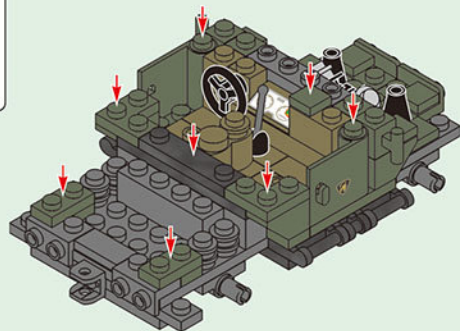

1-14

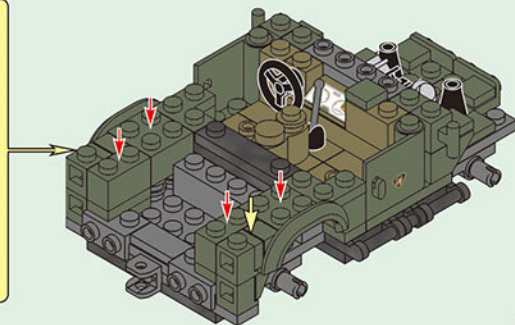
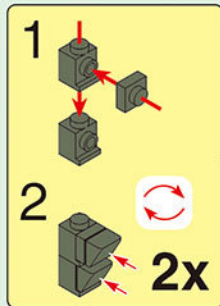

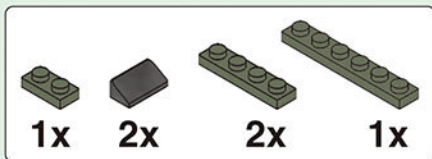

1-15

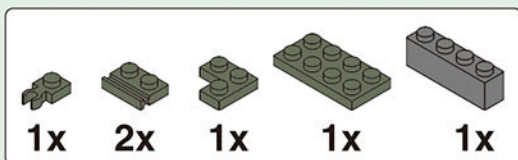
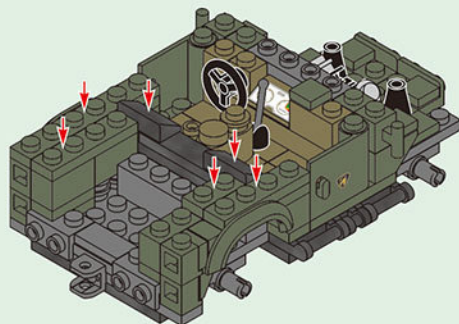

1-16

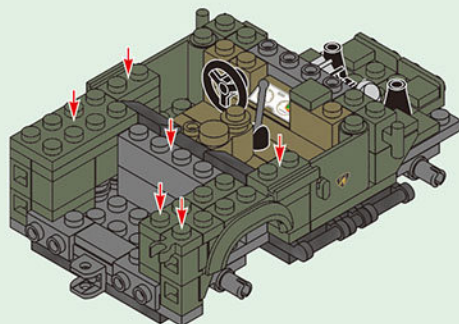

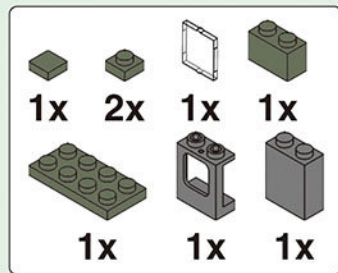

1-17

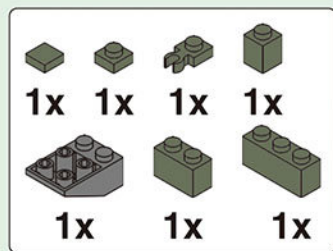
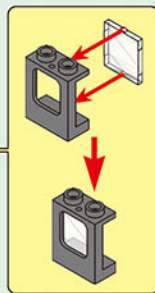
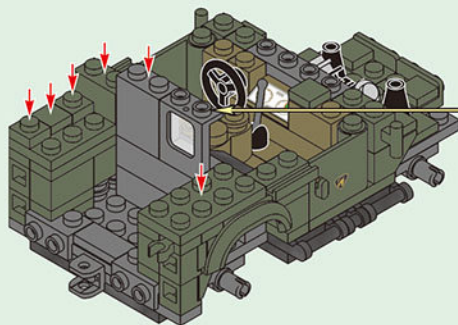

1-18

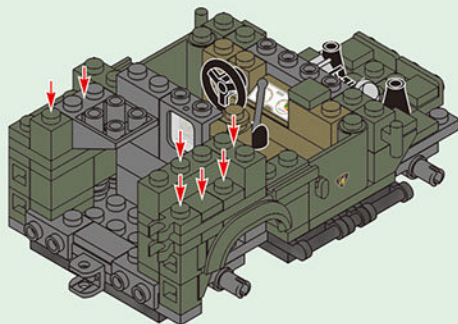

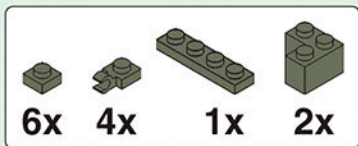

1-19

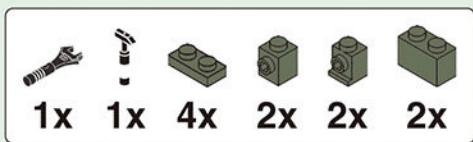
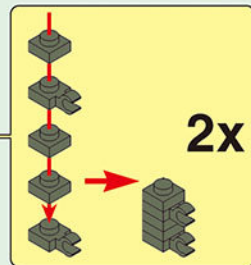
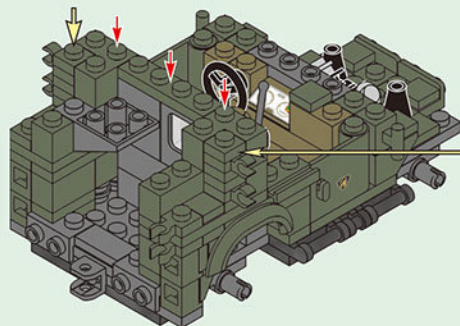

1-20

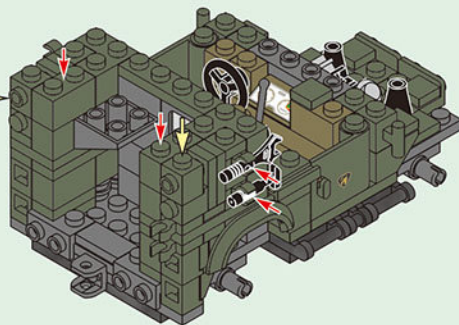
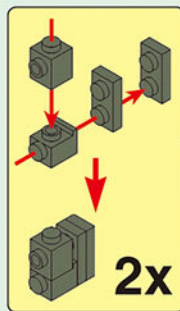

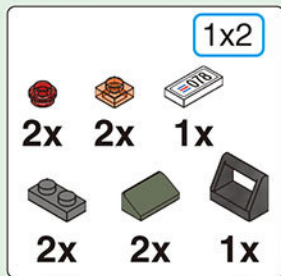

1-21

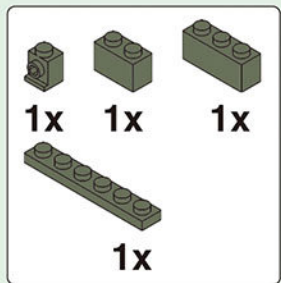
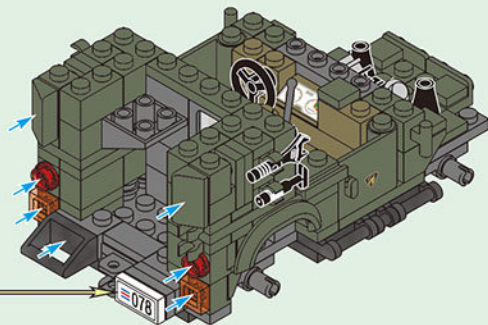
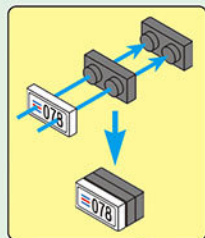

1-22.1

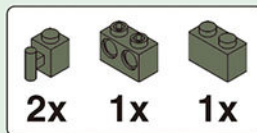
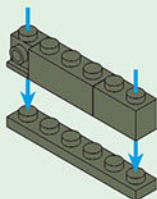

1-22.2

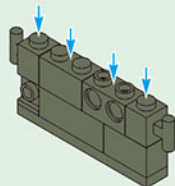

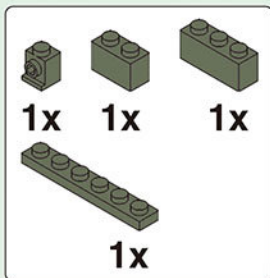

1-22.3

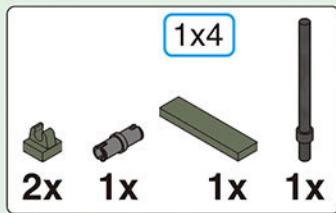
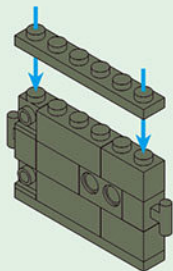

1-22.4

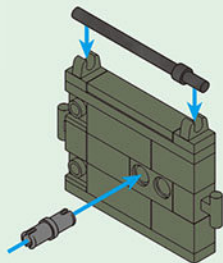

1-22.5

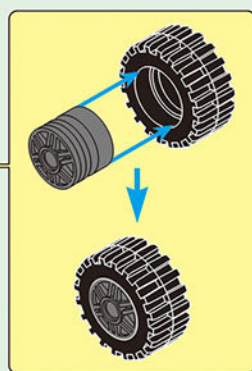
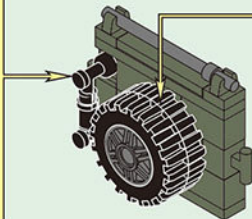

1-23

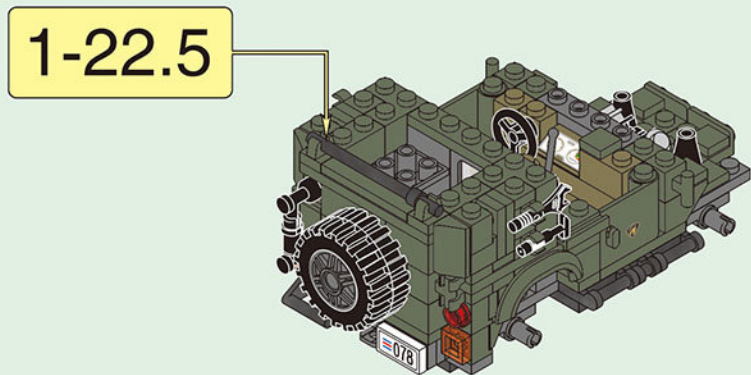

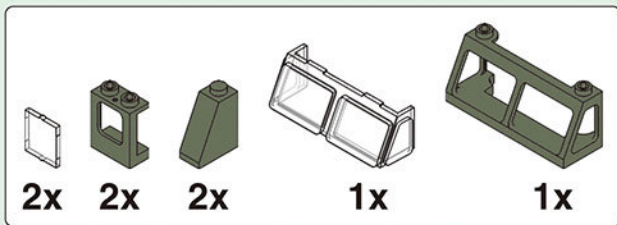

1-24

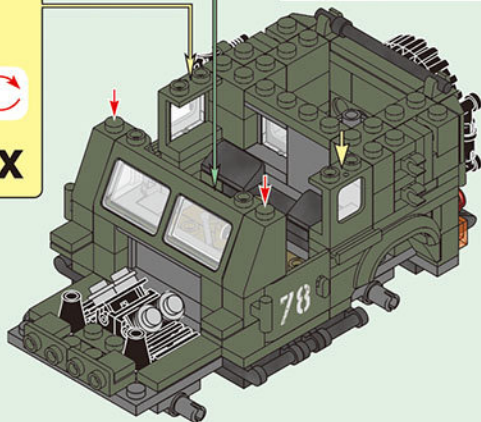
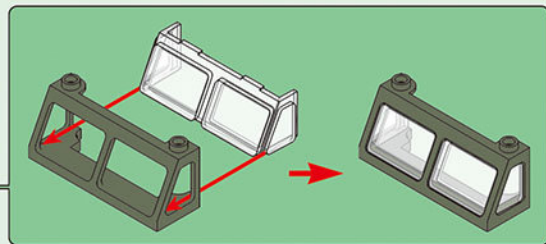
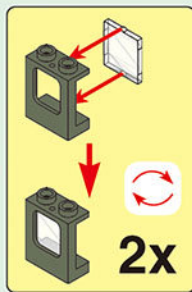

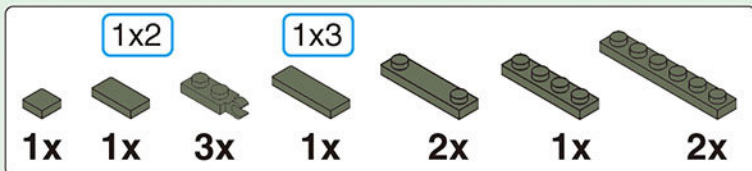

1-25

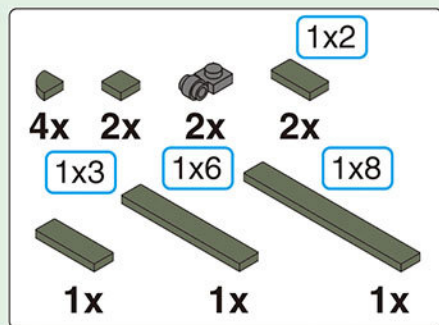
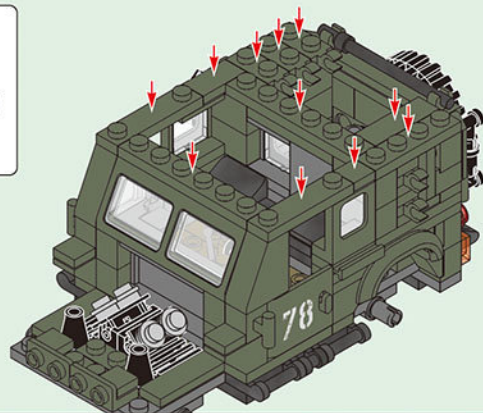

1-26

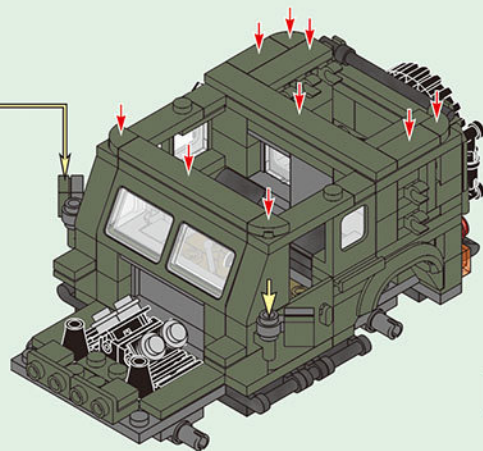
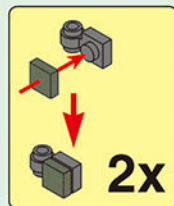



2

x5

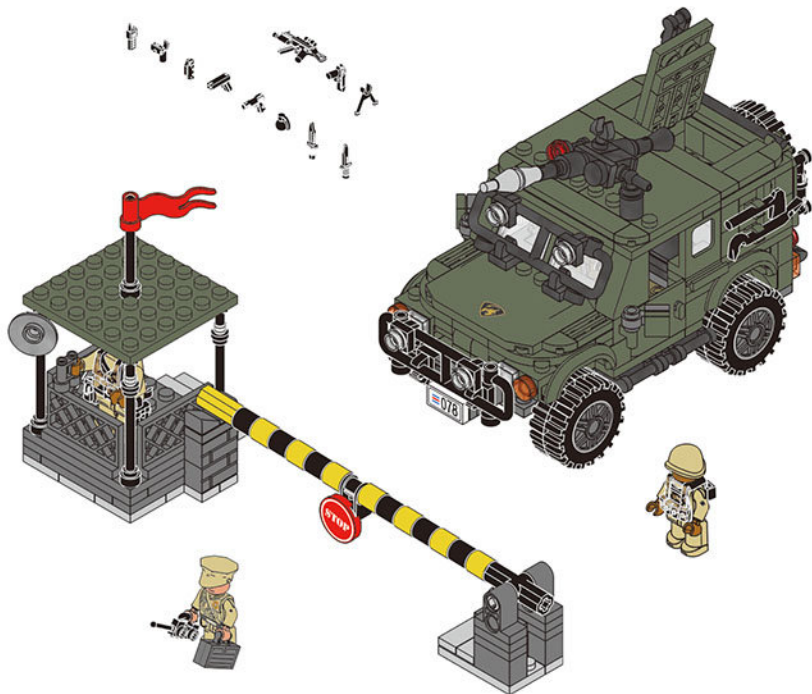

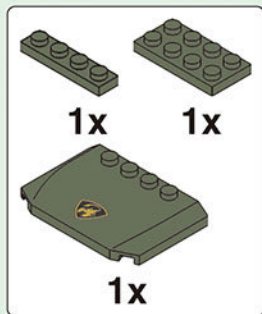

2-1.1

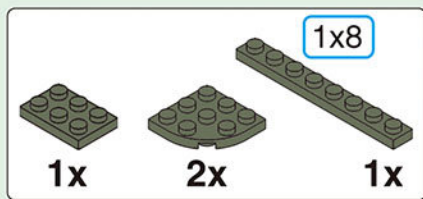
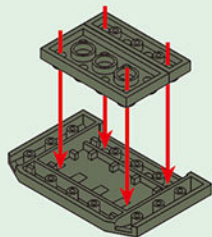

2-1.2

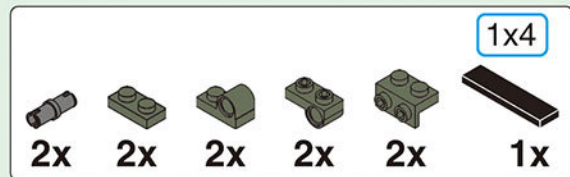
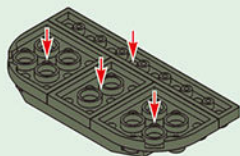

2-1.3

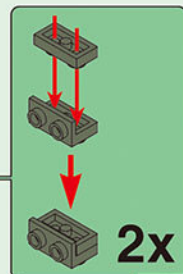
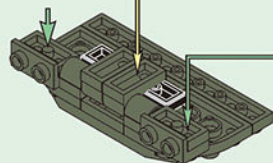
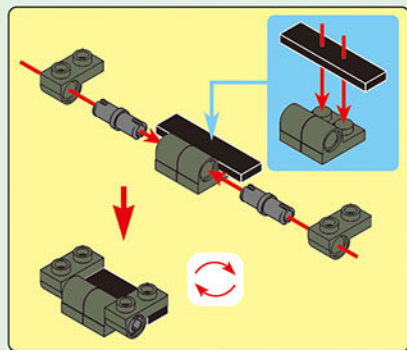

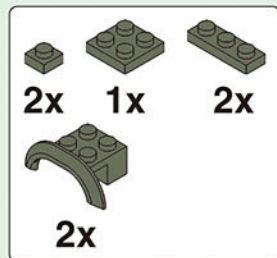

2-1.4

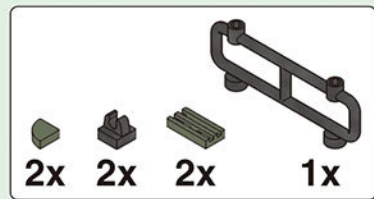
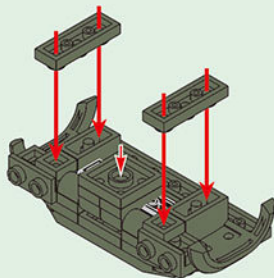

2-1.5

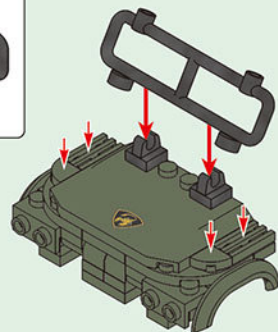

2-1.6

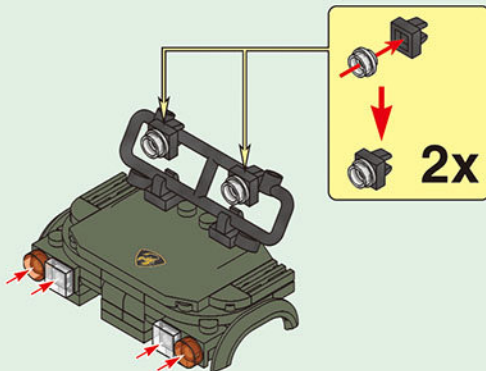

2-2

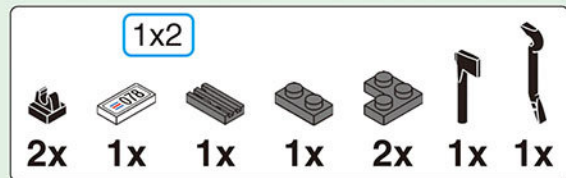
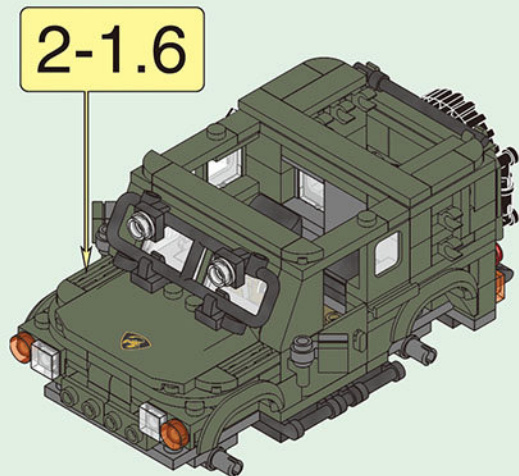

2-3

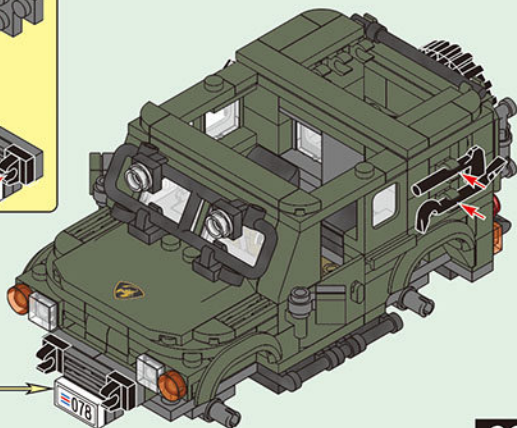
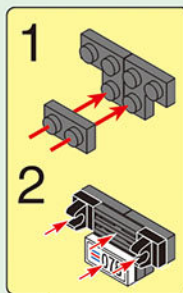

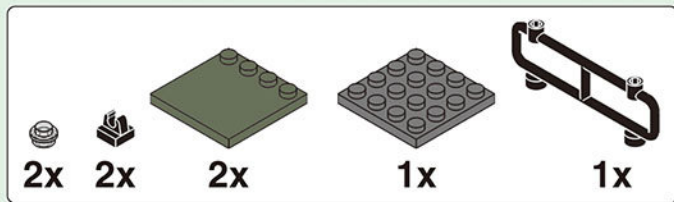

2-4

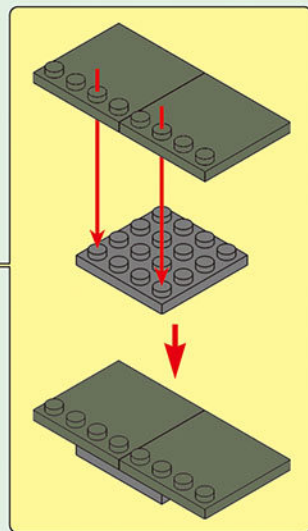
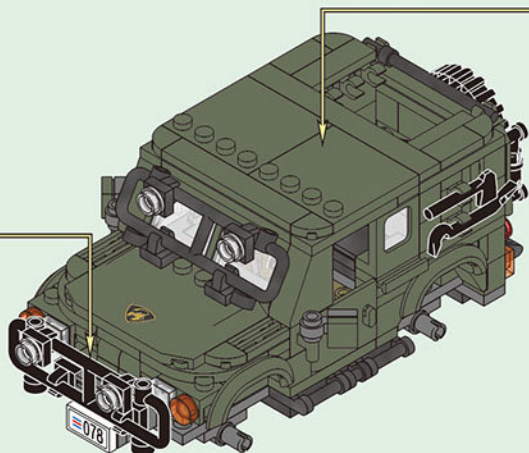
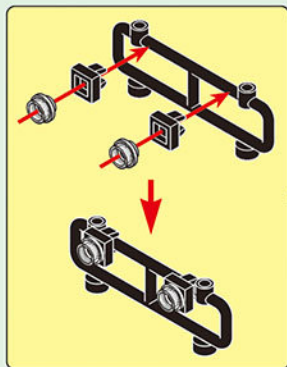

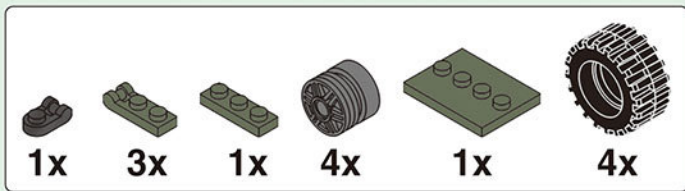

2-5

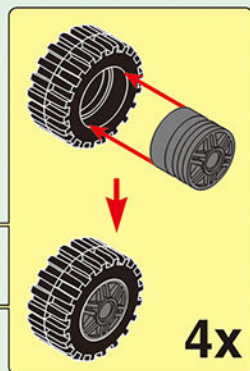
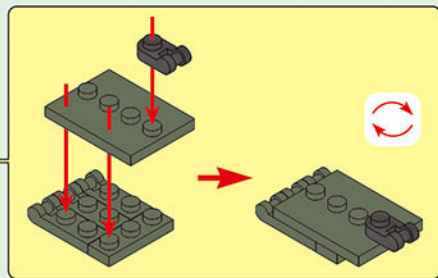
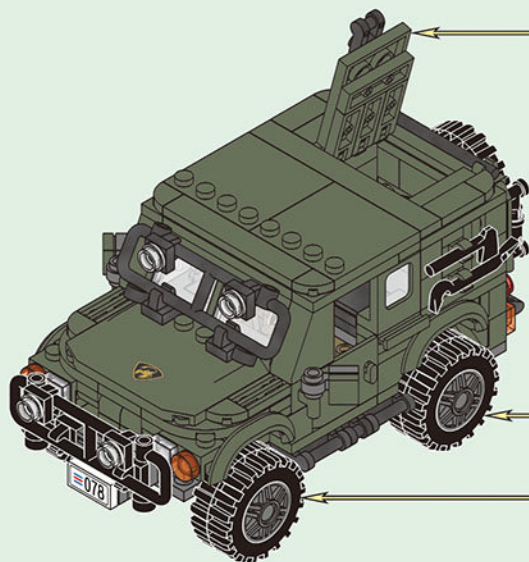

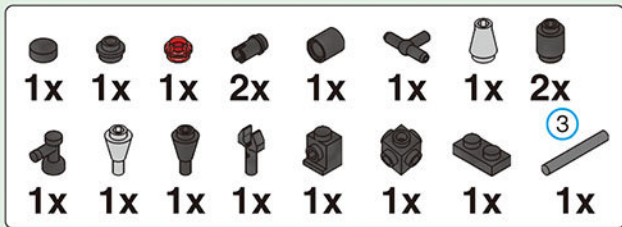

2-6



1

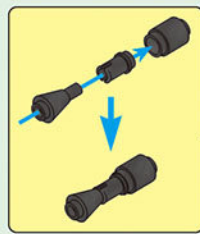
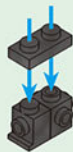

2

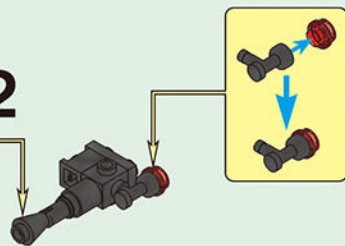

3

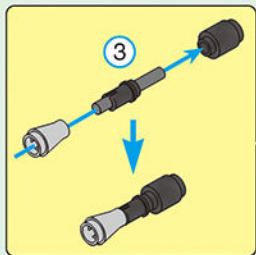

4

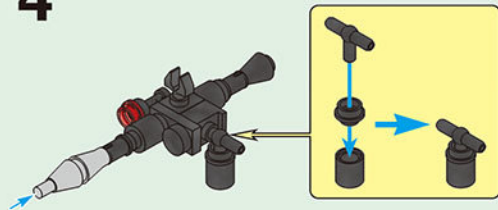

2-7

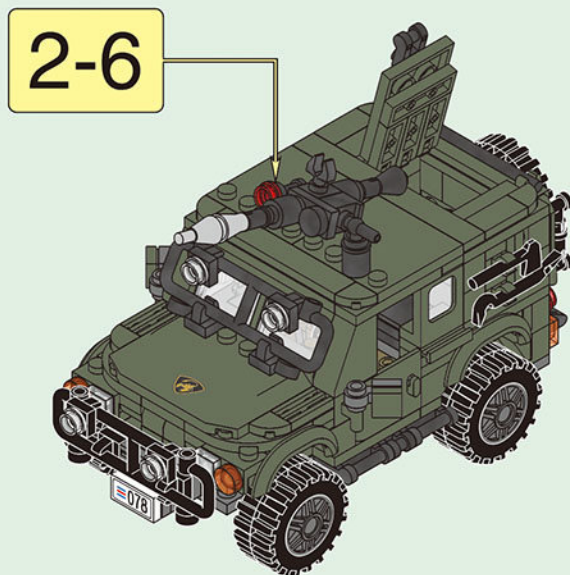

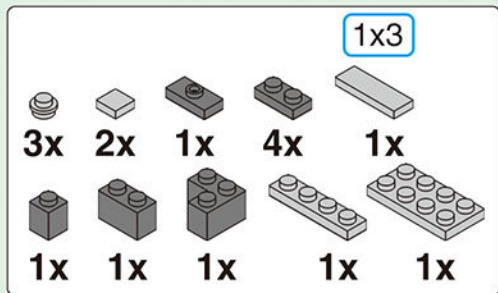

2-8

1

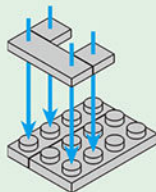

2

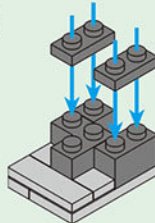

3

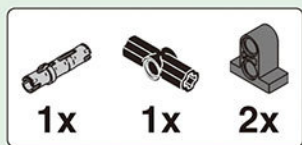
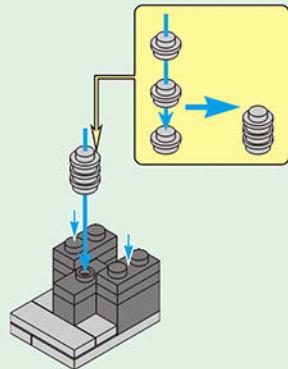

2-9

1

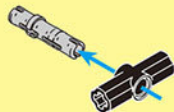

2

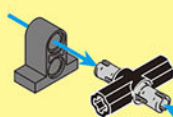

3



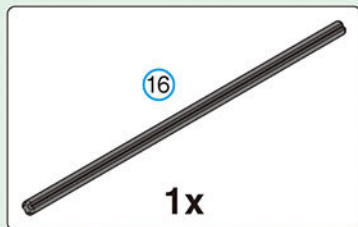

2-10

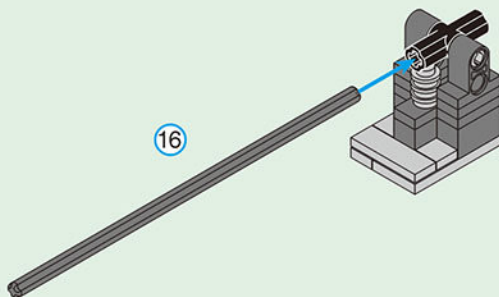

1:1 16



2-11

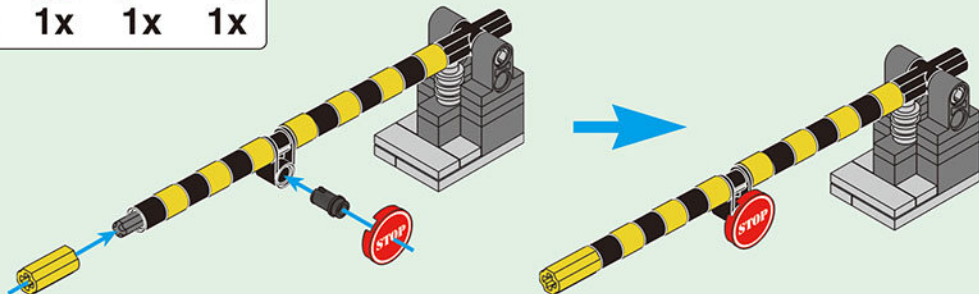

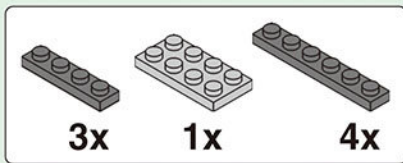

2-12

1

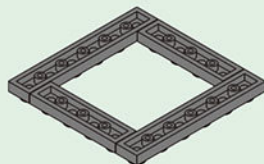

2

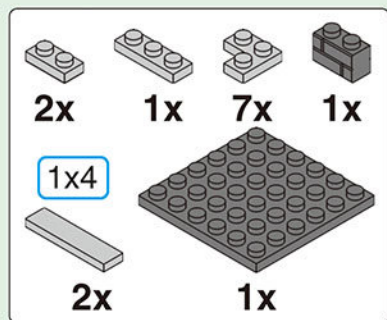
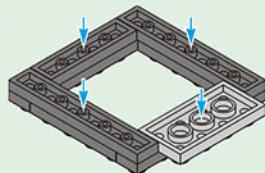

2-13

27

1

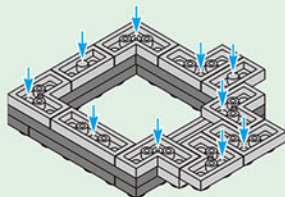

2

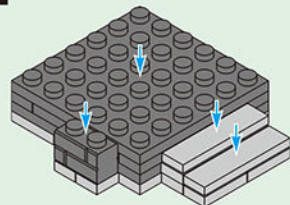

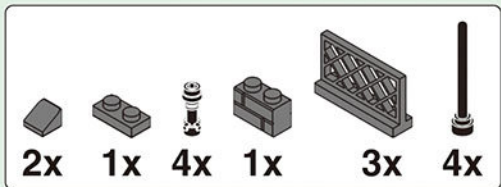

2-14

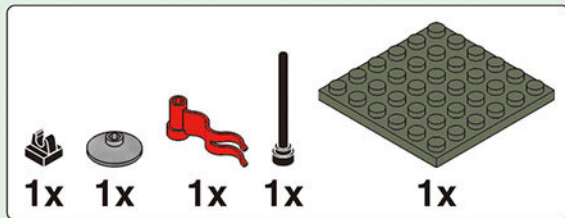
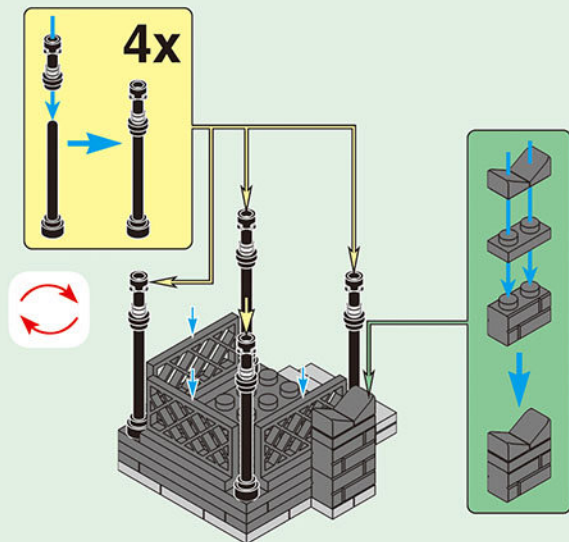

2-15

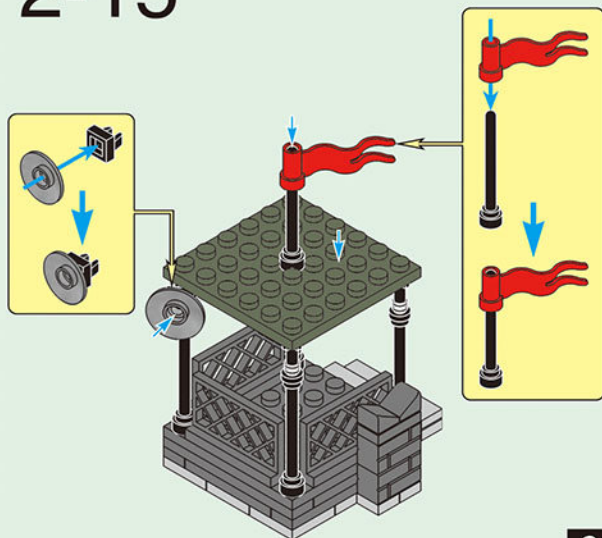

2-16

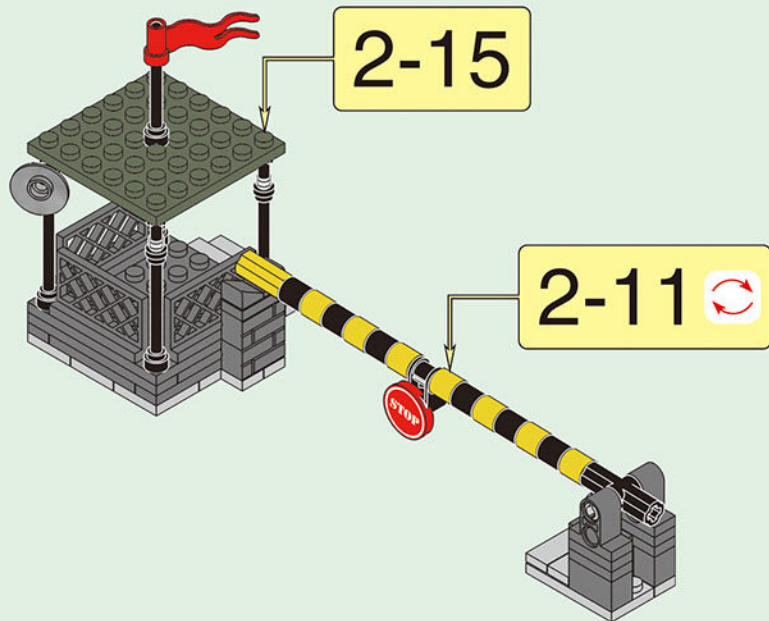

ACROSS THE BATTLEFIELD



DE: ACHTUNG! Nicht geeignet für Kinder unter 3 Jahren. Erstickungsgefahr, verschluckbare Kleinteile.
EN: WARNING! CHOKING HAZARD. Small parts. Not for children under 3 years.

FR: ATTENTION! Ne convient pas pour les enfants de moins de 3 ans. Contient de petites pièces.

NL: ATTENTIE! Niet geschikt voor kinderen beneden 3 jaar. Kleine onderdelen kunnen worden ingeslikt.

IT: ATTENZIONE! Non adatto a bambini di età inferiore ai 3 anni. A causa di piccole parti.

freakware GmbH, Karl-Ferdinand-Braun-Str. 33, 50170 Kerpen (Germany)

www.Klemmbausteine.eu



06012-18111-V2



< OPENABLE ROOF >



< OPENABLE TRUNK >



< OPENABLE BONNET >



< CAB INSIDE VIEW >



WEAPON
EQUIPPED WITH:

